

规格承认书

SPECIFICATION FOR APPROVAL

客户名称

Customer

客户料号

Customer No

产品类别

Product Type

电源适配器

Switch Power Adaptor

设计编号

Designed No.

产品型号

Model No.

GQ07-120050-DG

送样日期

Sample Date

版本

Version

A0

颜色

Colour

黑色

Black

白色

White

| 客户承认签核 CUSTOMER AUTHORIZED SIGNATURE | | |
|--------------------------------------|--|--|
| | | |

PLEASE SIGN AND RETURN ONE COPY 请签字确认并回传本司.

With your signature ,you agree that all contents in this approval sheet are correct and all production units will be manufactured according to the specification described in this sheet.

签字后, 您同意本承认书内容, 所有产品将按此要求生产.

REMARKS: Please make sure the EMI has been tested with your system/end application and the test result are conformed.

备注 : 请将我们的产品与配套产品终端连接测 EMI OK 后签字.

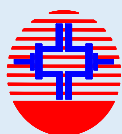

东莞市盈正电子有限公司

MITRA POWER SOLUTIONS CO.,LTD

电话(TEL): 0769-83733639

传真 (FAX): 0769-83732069

地址: 广东省东莞市横沥镇横沥兴达路23号1号楼101室

Add: Room 101, Building 1, NO.23 Xingda Road, Hengli Town Dongguan Guangdong ,

PEOPLE'S REPUBLIC OF CHINA

<http://www.mitra.cn>

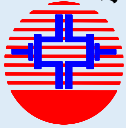

| | |
|--|----------|
| 1 HISTORICAL RECORD 变更记录 | 3 |
| 2 DESCRIPTION 概述 | |
| 2.1 Power Supply Description 产品概述..... | 4 |
| 2.2 Power Supply Change Notification 变更事前通知..... | 4 |
| 2.3 Power Supply Enclosure/housing 电源结构型式..... | 4 |
| 3 ELECTRICAL CHARACTERISTICS 电气性能 | |
| 3.1 AC Input Voltage and Frequency 输入电压及频率..... | 4 |
| 3.2 Maximum AC Current 最大输入电流..... | 4 |
| 3.3 Input Inrush Current 最大浪涌(突入)电流..... | 4 |
| 3.4 No-load Power Consumption 空载功耗..... | 4 |
| 3.5 Output Voltage 输出电压..... | 4 |
| 3.6 Output Ripple Voltage 输出纹波电压..... | 5 |
| 3.7 Time Sequence 时序特性..... | 5 |
| 3.8 Output Overshoot 输出过冲..... | 6 |
| 3.9 Output transient response 输出瞬态响应..... | 6 |
| 3.10 Protection Function 保护功能..... | 6 |
| 3.11 Efficiency 效率..... | 6 |
| 4 ENVIRONMENTAL REQUIREMENTS 环境要求 | |
| 4.1 Temperature 温度..... | 7 |
| 4.2 Relative Humidity 相对湿度..... | 7 |
| 4.3 The Sea Level Altitude 海拔高度..... | 7 |
| 4.4 Cooling Method 冷却方法..... | 7 |
| 5 Reliability 可靠性 | |
| 5.1 MTBF 平均故障间隔时间..... | 7 |
| 5.2 Insulation Resistance 绝缘阻抗..... | 8 |
| 5.3 Hi-Pot 绝缘耐压..... | 8 |
| 5.4 Leakage Current 漏电流..... | 8 |
| 5.5 Low Temperature Storage 低温存储..... | 8 |
| 5.6 High Temperature Storage 高温存储..... | 8 |

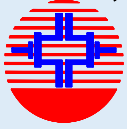

东莞市盈正电子有限公司

Mitra Power solutions Co., Ltd

Specification for Approval

Design No

Customer P/N

0

6 SAFETY STANDARD 安全标准

| | | |
|-----|---|---|
| 6.1 | Safety Standard 安规标准 | 9 |
| 6.2 | Electromagnetic Compatibility (EMC) 电磁兼容性 | 9 |

7 MECHANICAL CHARACTERISTICS 机械性能

| | | |
|-----|---|----|
| 7.1 | Bending Test 摇摆(弯曲)测试 | 9 |
| 7.2 | Tensile Strength Relief Test 拉力测试 | 9 |
| 7.3 | Drop Test 跌落测试 | 10 |
| 7.4 | Vibration test specifications non-operating with packing 振动测试 | 10 |
| 7.5 | Input Connection/country version 输入连接/國別 | 10 |
| 7.6 | Unit Weigth 产品单重 | 10 |

8 APPENDIX DRAWING 附图

| | | |
|-----|-----------------------------------|----|
| 8.1 | CIRCUIT DIAGRAM 电路图 | 11 |
| 8.2 | PRINT CIRCUIT BOARD LAYOUT 电路板布局图 | 12 |
| 8.3 | Overall Drawing 外观图 | 13 |
| 8.4 | Nameplate Drawing 铭牌图 | 14 |

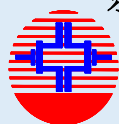

东莞市盈正电子有限公司

Mitra Power solutions Co., Ltd

Specification for Approval

Design No

Customer P/N

0

2.1 Power Supply Description 产品概述

This power Supply is designed for [home appliance](#) which convert 100Vac ~240Vac to a stabilized DC voltage of [12V](#) with rated output current of [0.5A](#).

本通用型家用电源是将100Vac ~240Vac 输入电压转换成稳定的直流电压 [12V](#), 额定输出电流 [0.5A](#)。

2.2 Power Supply Change Notification 变更事前通知

The vendor will notify customer for significant design changes, before the implementation. However, process improvements can be an exemption.

有重大设计变动时,在变更实施之前,供应商将通知到客户,工艺改善可以例外。

2.3 Power Supply Frame 电源结构型式

- Wall mount 插墙式
- Desk-top 桌上式
- Open frame 开放式结构/裸板
- Other 其它

3.0 ELECTRICAL CHARACTERISTICS 电气性能

3.1 AC Input Voltage and Frequency 输入电压及频率

3.1.1 Rated Input Voltage 额定输入电压 : [100-240Vac](#)

3.1.2 Reliable Input Voltage 可输入电压范围 : [90-264Vac](#)

3.1.3 Rated Input Frequency 额定输入频率: [50/60Hz](#)

3.1.4 Reliable Input Frequency 可输入频率范围 : [47-63Hz](#)

3.2 Maximum Input Current 最大输入电流

Input rated voltage, Output rated load. Input Current [0.3Amps](#) Maximum.

输入额定电压,输出额定负载条件下,最大输入电流为:[0.3Amps](#)。

3.3 Input Inrush Current 最大浪涌(突入)电流

Input [100Vac](#) 60Hz, Output rated load(cold start) inrush Current [80Amps](#) peak.

输入[100Vac](#) 60Hz,输出额定负载(冷启动)条件下,最大浪涌(突入)电流为:[80Amps](#)。

Input [240Vac](#) 50Hz, Output rated load(cold start) inrush Current [80Amps](#) peak.

输入[240Vac](#) 50Hz,输出额定负载(冷启动)条件下,最大浪涌(突入)电流为:[80Amps](#)。

3.4 No-load Loss Power 空载功耗

Input [115/230Vac](#), Output no load. Maximum loss power [0.1Watts](#).

输入[115/230Vac](#),输出空载,最大空载功耗为:[0.1瓦](#)。

3.5 Output Voltage 输出电压

| 负载 (Load) | 最小负载 (Min. Load) | 最大负载 (Max. Load) |
|-------------|------------------|------------------|
| 电流(Current) | 0A | 0.5A |
| 电压(Voltage) | 12Vdc ±5% | 12Vdc ±5% |

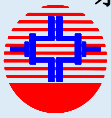

3.6 Output Ripple Voltage 输出纹波电压

3.6.1 The ripple noise voltage test is carried out under ambient 25°C
在环境温度25°C测试输出纹波电压.

3.6.2 Peak to peak ripple is measured with an oscilloscope with a bandwidth of 20MHz.
纹波量测时示波器选用20MHz带宽限制.

3.6.3 Measurement of ripple should parallel a 0.1uF ceramic capacitor and a 47uF electrolytic capacitor at the output of the measuring oscilloscope.
测试时在输出端要并联一颗0.1uF的陶瓷电容和一颗47uF的电解电容.

| Input | Output Rated Voltage | Output Current | Output Ripple & Noise |
|---------------|----------------------|----------------|-----------------------|
| 100Vac-240Vac | +12V | 0.5A | 200mVp-p Max. |

3.7 Time Sequence 时序特性

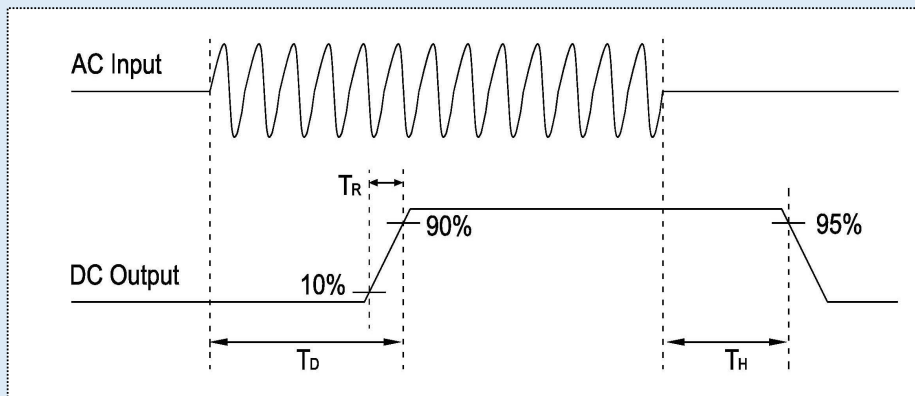

3.7.1 Turn-On Delay Time(T_D) 开机输出延迟时间:

The maximum cold start turn-on delay shall not exceed **3** second at input 100-240Vac and the rated load condition.

在输入100-240Vac,额定负载情况下,最大冷启动打开的延迟不会超出**3**秒.

3.7.2 Hold-Up Time(T_H) 关机输出维持时间:

The maximum turn-off hold-up time shall be least **5mS** at input 100Vac and the rated load condition.

在输入**100Vac**及额定负载情况下,关机输出维持时间不低于**5mS**.

The maximum turn-off hold-up time shall be least **10mS** at input 240Vac and the rated load condition.

在输入**240Vac**及额定负载情况下,关机输出维持时间不低于**10mS**.

3.7.3 Output Rise Time(T_R) 输出上升时间:

Input 100Vac/240Vac and rated load, The rise time shall not exceed **100mS** that the output voltage rise from **10%** to **90%** rated voltage.

在输入100Vac/240Vac,输出额定负载条件下,输出电压由**10%**额定电压上升至**90%**额定电压的上升时间不会超过**100mS**.

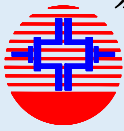

东莞市盈正电子有限公司

Mitra Power solutions Co., Ltd

Specification for Approval

Design No

Customer P/N

0

3.8 Output Overshoot 输出过冲

- 3.8.1 [10%](#) Rated Voltage Max. when the power turn on.
当电源开机时,过冲电压值最大为额定电压值的[10%](#).
- 3.8.2 [10%](#) Rated Voltage Max. when the power turn off.
当电源关机时,过冲电压值最大为额定电压值的[10%](#).

| Output Rated Voltage | Overshoot Voltage(V) | |
|----------------------|----------------------|----------|
| | Turn on | Turn off |
| +12V | 10% | 10% |

3.9 Output transient response 输出瞬态响应

| Output Voltage Tolerance Limited | Rate Slew | Load change |
|----------------------------------|-----------|-----------------|
| | | 负载变化 |
| 12Vdc±10% | 0.25A/μs | 20% to 80% Load |

Transient response measurements shall be made with a load changing repetition rate of 100Hz to 10kHz.
测量瞬态响应与负载改变的频率应在100Hz至10kHz。

3.10 Protection Function 保护功能

3.10.1 Over Voltage Protection 过压保护

The power supply shall protect itself from any over voltage condition.
电源在过压情况下可自动保护。

3.10.2 Over Current Protection 过流保护

In the input voltage 115/230Vac, The power supply shall protect itself from any over current condition.it can be automatically restored to be normal when the overcurrent condition removed, The minimum overcurrent protection point is [1.1](#) times of rated current.
在 115/230Vac输入时, 电源在过流情况下可自动保护,当过流情况解除后,可自动恢复正常。
最小过流保护点为额定电流的[1.1](#)倍。

3.10.3 Short Circuit Protection 短路保护

Shorting of output will not cause power supply to damage, or any safety hazard.
The power supply shall resume normal operation after the short is removed.
输出短路时电源不会损坏,不会有任何的安全危险,短路解除后电源恢复正常工作。

3.10.4 Input Protection 输入保护

The power supply has a [fuse resistor](#) to protect itself.
该电源由一颗电阻保险丝来达到输入保护。

3.11 Efficiency 效率

Input [115/230Vac](#). and 100%,75%,50%,25% Rated Load condition. Average efficiency (η):[78.88%](#) Min(Meet DOE/ERP [VI](#)).

在输入[115/230Vac](#),输出100%,75%,50%,25%额定负载,平均效率 (η): [78.88%](#) Min (符合DOE/ERP [VI](#)等级).

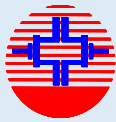

东莞市盈正电子有限公司

Mitra Power solutions Co., Ltd

Specification for Approval

Design No

Customer P/N

0

4.0 ENVIRONMENTAL REQUIREMENTS 环境要求

4.1 Temperature 温度

4.1.1 Storage temperature (Non-operating) 可存储温度(非操作状态):

-10 to 70 degrees C [-10] 至 [70]摄氏度.

Typical values:25 degrees C. 典型值:25摄氏度.

4.1.2 Operating temperature Limits 可操作温度:

0 to 40 degrees C. [0] 至 [40]摄氏度.

Typical values:25 degrees C. 典型值:25摄氏度.

4.2 Relative Humidity 相对湿度

4.2.1 Storage Humidity (Non-operating) 存储湿度(非操作状态):

5% to 90% RH (Non-condensing) [5%] 至 [90%],无凝水状态.

4.2.2 Operating Humidity Limits 操作湿度:

5% to 90% RH (Non-condensing) [5%] 至 [90%],无凝水状态.

4.3 The Sea Level Altitude 海拔高度

4.3.1 Storage Altitude 可存储海拔度(非操作状态):

0 to +2,000m above the sea level [0] 至 [2,000]米.

4.3.2 Operating Altitude 可工作海拔度:

0 to +2,000m above the sea level [0] 至 [2,000]米.

4.4 Cooling Method 冷却方法

Natural air convection 自然冷却

5.0 Reliability 可靠性

5.1 MTBF: Mean Time Between Failure 平均故障间隔时间

The power supply shall be designed and manufactured to have more than50,000 operating hours (about 5.7 years for 24-hour-operation a day) of mean time between failure (MTBF) at 90% of confidence level while operating under the prevailing conditions below 0.1% Average field failure rate @ 25°C.

在如下条件,该电源设计和制造平均故障间隔时间(MTBF)将超过50,000个操作时间(大约操作24小时/每天/5.7年),信心指数为90%,平均现场故障率0.1%。

Input Voltage: 115/230Vac

输入电压: 115/230Vac

Output Load: of Rated load

输出负载: 额定负载条件

Ambient Temperature: at 25 degrees C Room Temperature

环境温度: 室温25摄氏度

Standard 标准: MIL-STD-HDBK-217

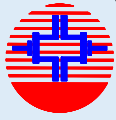

东莞市盈正电子有限公司

Mitra Power solutions Co., Ltd

Specification for Approval

Design No

Customer P/N

0

5.2 Insulation Resistance 绝缘阻抗

| Test Points | 检测部位 | Condition & Specification 条件及规格 |
|-----------------|---------|---|
| Input to Output | 输入-输出 | 500Vdc 100MΩ min. (at ambient temperature 25 degree C, humidity 90%) 500Vdc 100MΩ 最小. (在室温25摄氏度,湿度90%条件下). |
| Input to Case | 输入-外壳 | 500Vdc 100MΩ min. (at ambient temperature 25 degree C, humidity 90%) 500Vdc 100MΩ 最小. (在室温25摄氏度,湿度90%条件下). |
| Output To Case | 输出 - 外壳 | Non Isolated |

5.3 Hi-Pot 绝缘耐压

| Test Points | 检测部位 | Condition & Specification 条件及规格 |
|-----------------|-------|---------------------------------|
| Input to Output | 输入-输出 | 4200Vac 50Hz, 60S, ≤5mA. |
| Input to Case | 输入-外壳 | 4200Vac 50Hz, 60S, ≤5mA. |
| Output to Case | 输出-外壳 | Non Isolated |

When the voltage of 4.2KVac is applied, and the voltage applied to the insulation under test is gradually raised from zero to the prescribed voltage in 0.1s, and held at that value for 60s between the input and output and between the input and housing, the current sensitivity shall be less than 5mA. After this test, the adapter shall exhibit no electrical and mechanical abnormalities. (voltage of 4.2KVac, 2s and sensitivity current 5mA shall be applied to the product line).

在输入端对输出端及输入端对外壳间施加了 4.2KVac 电压, 并且测试中施加在绝缘上的电压是在 0.1s 内由 0V 逐渐上升到规定值, 然后保持 60S, 电流灵敏度设置在 5mA。经过以上测试, 电源应不发生电气及机械上的异常。(注: 在生产线上批量生产时以 4.2KVac, 2s 5mA 进行测试)。

5.4 Leakage Current 漏电流

The leakage current shall not exceed 0.7mA for Class II when power supply is operated maximum input voltage and maximum load.

当电源供应器操作在最大输入及最大负载情况下, 其漏电流应小于 0.7mA, 满足 Class II 等级。

5.5 Low Temperature Storage 低温存储

Keep the parts unpacked without connecting to the power for 96 hours at -10°C. Electrical character tested and appearance after resuming 1 hours at room temperature. The electrical performance and appearance should be normal.

产品不包装, 不通电。在 -10°C 条件下保存 96 小时, 常温恢复 1 小时后, 进行外观、电气性能检测。产品电气性能及外观应是正常的。

5.6 High Temperature Storage 高温存储

Keep the parts unpacked without connecting to the power for 96 hours at 70°C. Electrical character tested and appearance after resuming 1 hours at room temperature. The electrical performance and appearance should be normal.

产品不包装, 不通电。在 70°C 条件下保存 96 小时, 常温恢复 1 小时后, 进行外观、电气性能检测。产品电气性能及外观应是正常的。



东莞市盈正电子有限公司

Mitra Power solutions Co., Ltd

Specification for Approval

Design No

Customer P/N

0

6.0 STANDARD 标准

6.1 SAFETY STANDARD 安全标准

* Meet [EN61558-2-16](#)

6.2 ELECTROMAGNETIC COMPATIBILITY (EMC) 电磁兼容性

6.2.1 EMI 电磁干扰

This power supply shall compliance with the following Criterion 本电源将遵照以下标准:

6.2.1.1 Conduction Emission 传导干扰度

* [EN55014-1/EN55014-2](#)

6.2.1.2 Radiated Emission 辐射干扰度

* [EN55014-1/EN55014-2](#)

6.2.2.1 ESD 静电抗扰度

Standard: * [EN61000-4-2](#)

AIR DISCHARGE at [8KV](#), CONTACT DISCHARGE at [4KV](#).

6.2.2.2 Surge 雷击浪涌

differential mode: [1KV](#)

common mode: [2KV](#)

The common mode must test with end application. 共模雷击搭配客户产品测试.

Remarks: EMC-SPECIFICATION test with the Pure resistance as load to test,and we only responsible for the product we supplied.

电磁兼容性测试是以纯电阻作为负载测试的，我们只对单品测试负责。

7.0 MECHANICAL CHARACTERISTICS 机械性能

7.1 Bending Test 摇摆(弯曲)测试

Test the metallurgical equipment with fixed plug,handing weight is [300g](#),
[±60](#) degrees from side to side, swing [45](#) times per minute, swing more than [1000](#) times
(Remark: ±60 degrees, that is to say 120 degrees for a cycle,counting 1 times)

以测试治具固定Plug,吊重[300g](#),左右摇摆[±60](#)度,每分钟摇摆[45](#)次, 摇摆[1000](#)次以上(注:±60度即120度为一个循环,算1次)

7.2 Tensile Strength Test 拉力测试

put the weight of [4 kg](#) on SR for [1](#) minute, SR should not shift or damage.

put the weight of [7 kg](#) on DC Cable after [1](#) minute,inner core shall not break .

在DC线的SR卡上施以[4Kg](#)之重量[1](#)分钟, 产品无短路, 无开路, 围卡无松脱。

在DC线线体上施以[7Kg](#)之重量[1](#)分钟后, 检查内芯不可有拉断现象。



东莞市盈正电子有限公司

Mitra Power solutions Co., Ltd

Specification for Approval

Design No

Customer P/N

0

7.3 Drop Test 跌落测试

The adapter shall exhibit no abnormality in mechanical or electrical performance when it is dropped 6 times to hardwood(20mm thickness) from a height of 1m, with each of the 6 different sides of the adapter 1 times. The electrical and mechanical performance should be normal after the tested. Small nicks or slight deformations in the corners of the housing, or cracks not penetrating the inside may be accepted. (at:25°C±5°C).

适配器经过落地测试后应无机械或电气性能异常,从1m垂直高度自由跌落到20mm厚度的硬木质板上(硬木质板应放置于水泥基座或同等无弹性的地面上),共跌落6次,6个不同面各1次. 测试后产品电气和机械功能正常,外观或角落有轻微的变形或出现不穿透裂纹是可以接受的(在25°C±5°C)。

7.4 Vibration test specifications non-operating with packing 振动测试(未运行,带包装)

10Hz to 55Hz with sweep at a breadth 2.0mm for 20 Minutes for each of the perpendicular axes X,Y,Z. After the test the electrical performance shall be normal.

振动频率: 10Hz-50Hz; 振幅:2mm; X、Y、Z三个方向各20分钟; 振动测试后产品电气性能应是正常的。

7.5 Input Connection/country version 输入连接/國別 :

7.5.1.1 Wall plug or Cord to Cord Type 插墙式或导线式

- For European/欧规
- For US 3PIN/美规
- For China/中规
- For Japanese/日规
- For UK 3PIN/英规
- For Korea/韩规
- For Argentina/阿根廷
- For Australia/澳规
- For US/美规
- For Brazil/巴西规
- For Singapora/新加坡
- ROC (Taiwan) /台湾规

7.5.1.2 Desktop Socket and Terminal Type 桌上型母座或端子式

- 2PIN Socket
- 3PIN Socket
- Terminal type

7.6 Unit Weigth 产品单重

The weight of the unit power supply shall be about 63.49 g(Ref).

产品单重大约: 63.49 克 (供参考).

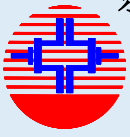

8.1 CIRCUIT DIAGRAM 电路图(供参考)

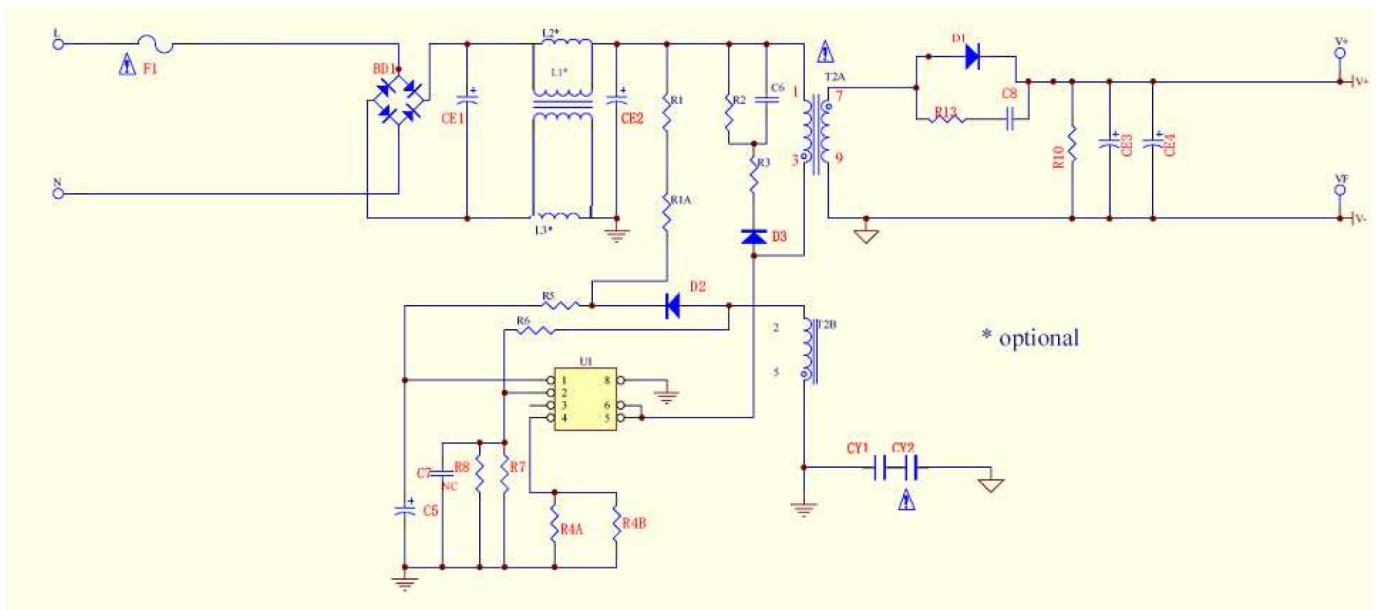

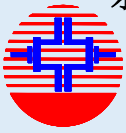

东莞市盈正电子有限公司
Mitra Power solutions Co., Ltd

Specification for Approval

Design No

Customer P/N

0

8.2 Screen printing figure 丝印图(供参考)

TOP OVERLAY

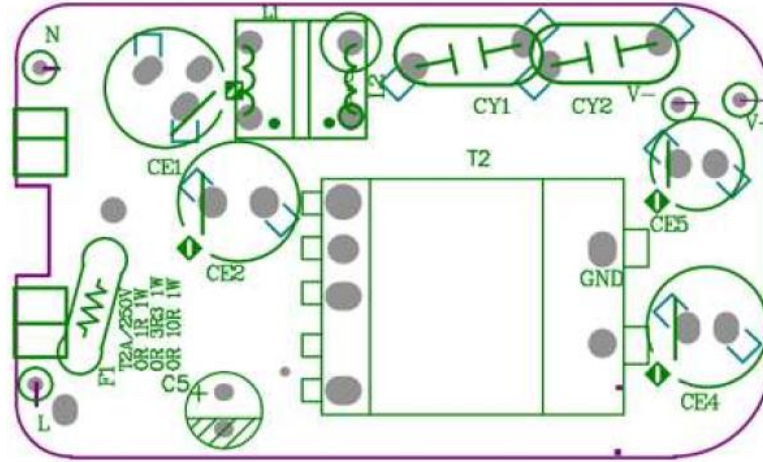

BOTTOM OVERLAY

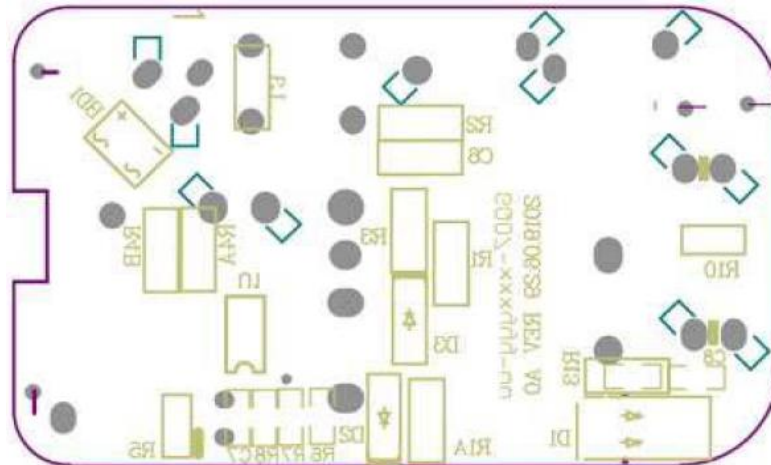

BOTTOM LAYER

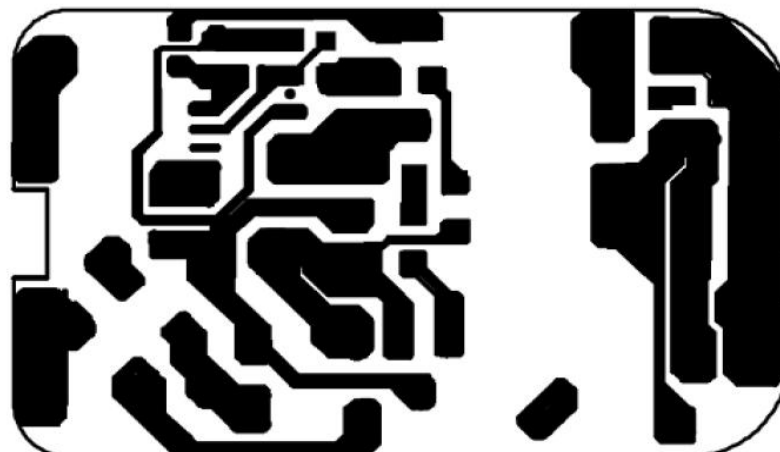



8.3 Overall Drawing 外观图

外壳(Enclosure): BLACK(LEAD FREE) 外壳: 黑色

外壳尺寸(The power supply size): L:58*W:37*H:25mm

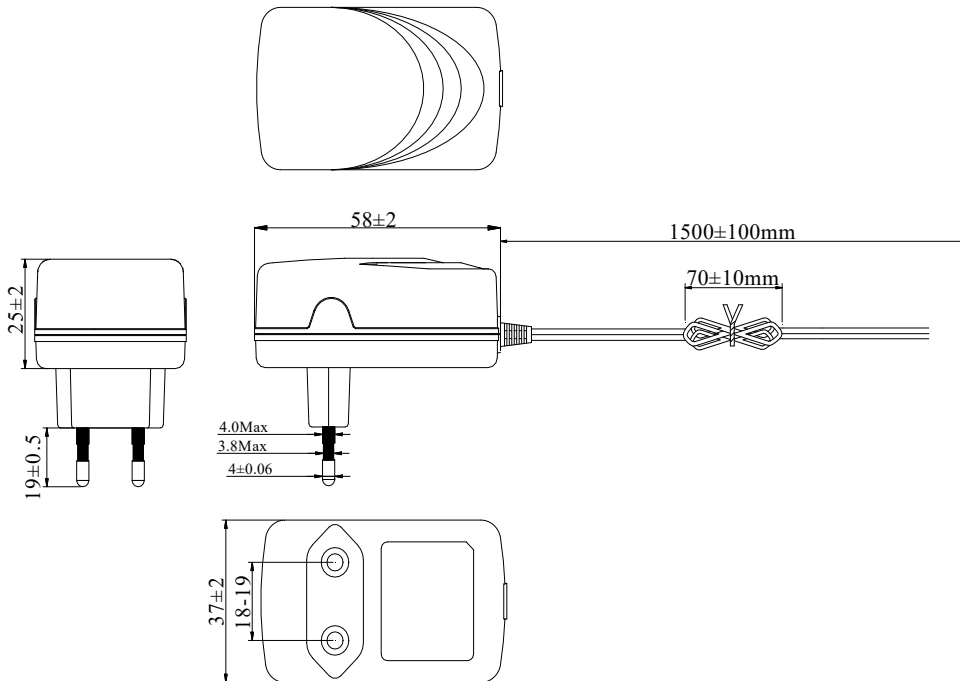

| | | | |
|-----------------|--|-----------|---|
| 中规 | <p>1.45~1.65 15.65~16.35 6.18~6.40</p> | 英规 BS | <p>22.23~23.23 3.9~4.05 7.8~8.05 6.22~6.48 3.9~4.05 17.2~18.2</p> |
| 美规/日规 UL/PSE | <p>1.40~1.65 6.10~6.60 15.88~18.24</p> | 澳规 SAA | <p>9±0.3 17±0.3</p> |
| 欧规 GS | <p>19±0.5 4.0Max 3.8Max 4±0.06</p> | 韩规 | <p>4.6±0.2 4.3Max 4.74~4.86 19±0.5</p> |

DC线规格 (DC CABLE SPEC) :

UL2468 20AWG 1.5M 黑色 (BLACK) DC头待定

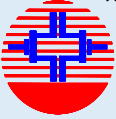
| | | |
|---|-----------------------------------|---------------------|
|  东莞市盈正电子有限公司 Mitra Power solutions Co., Ltd | Specification for Approval | |
| | Design No | Customer P/N |
| | 0 | |

8.4 Nameplate Drawing 铭牌图

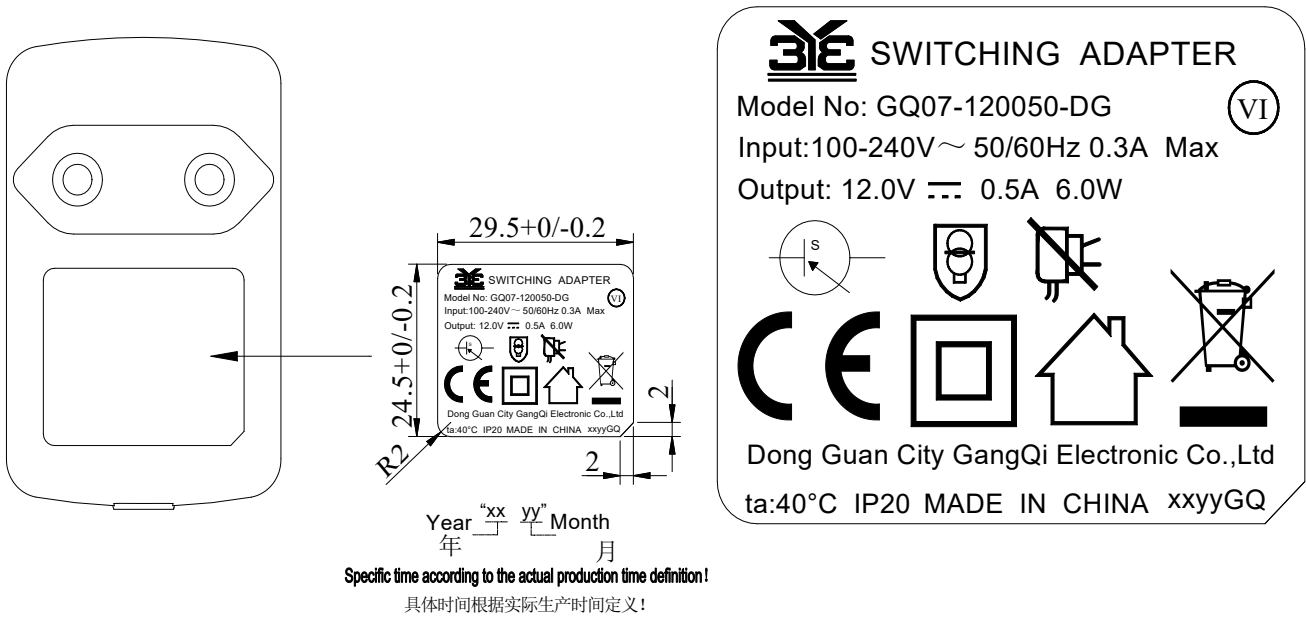

Note: 此铭牌内容镭雕于外壳，外框线不用镭雕

Note: Marking will be laser printed(engraved)onto the housing/case.